

**JET<sup>®</sup>**

**GODETS D'ÉLÉVATEUR**

**ELEVATOR BUCKETS**



**STIF**

components for your success

- ▶ Français
- ▶ English



Fondée en 1984, S.T.I.F s'est créé une solide réputation de spécialiste du composant pour le vrac et plus particulièrement du godet d'élévateur en créant la gamme JET "ORIGINAL". Dès 1989, le godet JET a révolutionné le monde de l'élévation en apportant une solution fiable et économique pour tous les produits, avec des vitesses faibles ou élevées dans toutes les industries: Agro alimentaires, silos, Usine d'Aliments du Bétail, moulins..., Industries lourdes, Installations portuaires.

En quelques années, la gamme JET est devenue incontournable dans de nombreux pays. Ce catalogue vous présente tous les modèles de la gamme.

Established in 1984, S.T.I.F has built up a well established reputation as specialists in components for bulk handling products, particularly elevator buckets, by creating the "original" JET range. Since 1989, the JET elevator bucket has revolutionized the elevation sector by providing a reliable, economical solution for all slow and fast-flowing products, in all industries: Agri-food, silos, feed mills, flour mills..., heavy industry, port facilities.

In just a few years, the JET product range has made itself indispensable in numerous countries. This catalogue features all the models in the range.



les composants de votre réussite

Z.A. de la Lande — 49170 Saint-Georges-sur-Loire — FRANCE — Tél.: +33 2 41 72 16 82 — Fax: +33 2 41 39 32 12

E mail: [sales@stifnet.com](mailto:sales@stifnet.com) — Web: [www.stifnet.com](http://www.stifnet.com)

## JET®

- Conçu pour répondre à tous les produits courants avec des vitesses faibles ou rapides.
- Godet version acier embouti de forte épaisseur, très longue durée de vie et résistance optimale garantie. (ép. de 1 à 4 mm acier ou inox)
- Godet version polymère de très haute qualité (HDPE; PA 6 nylon; PU; HDPE Atex) garantissant une longue durée de vie et une excellente résistance.
- Adapté à tous produits.
- Designed for use with all slow or fast-flowing products.
- Thick pressed steel bucket version, extended lifespan and optimal resistance guaranteed. (1 to 4 mm thick steel or stainless steel)
- Very high-quality polymer bucket version (HDPE; PA 6 nylon; PU; HDPE Atex) guaranteeing an extended lifespan and excellent resistance.
- Suitable for all products.

## EUROJET®

- Conçu pour répondre aux produits à écoulement difficile.
- Godet version acier embouti de forte épaisseur, longue durée de vie et bonne résistance garanties. (ép. de 1 à 3 mm acier ou inox)
- Godet version polymère de très haute qualité (HDPE; PA 6 nylon; PU) garantissant une bonne durée de vie et une bonne résistance.
- Particulièrement adapté aux vitesses très faibles et très rapides.
- Designed for use with difficult-flowing products.
- Thick pressed steel bucket version, extended lifespan and optimal resistance guaranteed. (1 to 2.5 mm thick steel or stainless steel)
- Very high-quality polymer bucket version (HDPE; PA 6 nylon; PU) guaranteeing an extended lifespan and excellent resistance.
- Particularly suitable for very low and very high-speed flows.

## JETCC®

- Profond, de grande capacité.
- Conçu pour répondre aux produits coulant à vitesses moyennes et rapides.
- Godet version polymères de très haute qualité (HDPE; PA 6 nylon) garantissant une bonne durée de vie et une bonne résistance.
- Particulièrement adapté aux céréales.
- Deep-bottomed with high capacity.
- Designed for use with products flowing at average and high speeds.
- Very high-quality polymer bucket version (HDPE; PA 6 nylon) guaranteeing an extended lifespan and excellent resistance.
- Particularly suitable for grain.

## Columbus DIN 15232

- Conçu pour répondre aux produits coulant à vitesses moyennes
- Version acier embouti de forte épaisseur, bonne durée de vie et une bonne résistance. (ép. de 1 à 2,5 mm acier)
- Godet version polymère de très haute qualité (HDPE; PA 6 nylon) garantissant une bonne durée de vie et une bonne résistance
- Adapté aux céréales et granuleux
- Designed for use with products flowing at average speeds.
- Thick pressed steel bucket version, highly durable and resistant (1 to 2.5 mm thick steel)
- Very high-quality polymer bucket version (HDPE; PA 6 nylon) guaranteeing an extended lifespan and excellent resistance.
- Suitable for grain and granular products.



**JET®**

GODET D'ÉLEVATEUR / ELEVATOR BUCKET

**SOMMAIRE**

SUMMARY

**JET®**  
Acier - Steel  
  
**P.6**

**JET®**  
HDPE/PA6/PU/PA ATEX  
  
**P.7**

**EUROJET®**  
Acier - Steel  
  
**P.8**

**EUROJET®**  
HDPE/PA6/PU/PA ATEX  
  
**P.9**

**JETCC®**  
HDPE/PA 6  
  
**P.10**

**JETCC®** Low Profile  
HDPE/PA 6  
  
**P.11**

**MAXIJET®**  
HDPE/PA6/PU/PA ATEX  
  
**P.12**

**JET-LIFT®**  
Acier - Steel  
  
**P.13**

**Columbus**  
Acier - Steel  
HDPE/PA 6  
  
**P.14**

**NORMAJET®**  
Acier - Steel  
  
**P.16**

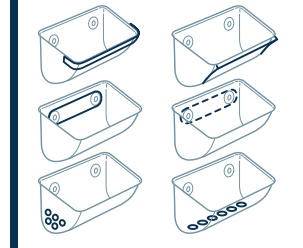
**Options**  
  
**P.16**

**Jonction & Boulonnerie**  
Junction & Bolt  
  
**P.17**

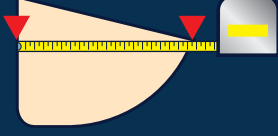
**Comment mesurer un godet ?**  
How to measure a bucket?  
  
**P.18**

**STIF**  
**C'est aussi :**  
Sangles  
Appareil de sécurité  
Events d'explosion  
**It's also :**  
Elevator belt  
Safety equipment  
Explosion vent panel  
**P.19**



### GUIDE CHOIX MATIÈRE HOW TO CHOOSE OUR MATERIAL

MATERIAUX MATERIALS	Acier Steel	Inox 304L Stainless Steel 304L	Inox 316L Stainless Steel 316L	PEHD HDPE	PA 6 PA 6/6*	PU	PA ATEX
LONGEVITÉ LONGEVITY	***	****	****	*	***	***	**
PRODUITS COLLANTS STICKY PRODUCTS	***	***	***	*	***	***	***
TENUE A L'IMPACT IMPACT PERFORMANCE	**	***	***	**	***	***	*
ALIMENTAIRE FOOD GRADE	X	✓	✓	✓	✓	✓	X
TEMPERATURE °C EN CONTINU CONTINUOUS TEMPERATURE °C	+180°C -270°C	+250°C -270°C	+250°C -270°C	+70°C -40°C	+100°C +120°C* -10°C	+70°C 0°C	+100°C -20°C
TEMPERATURE °C EN POINTE TOP TEMPERATURE °C	200°C	400°C	400°C	80°C	120°C 130°C*	80°C	120°C
RESISTIVITÉ RESISTIVITY	✓ Conducteur Conductor	✓ Conducteur Conductor	✓ Conducteur Conductor	X Isolant Insulator	X Isolant Insulator	X Isolant Insulator	Dissipateur Dissipating <   Gohms
PRIX PRICE	*	***	****	*	***	****	****
COULEUR COLOUR	-	-	-	Blanc White	Crème Cream	Vert Green	Crème Cream
DENSITÉ DENSITY	7,85	7,85	7,85	0,96	1,14	1,19	1,14
APPLICATIONS APPLICATIONS	<ul style="list-style-type: none"> <li>• Céréales</li> <li>• Industrie</li> <li>• Cereals</li> <li>• Industry</li> </ul>	<ul style="list-style-type: none"> <li>• Alimentaire</li> <li>• Corrosion</li> <li>• Température</li> <li>• Food</li> <li>• Corrosion</li> <li>• Temperature</li> </ul>	<ul style="list-style-type: none"> <li>• Alimentaire</li> <li>• Forte Corrosion</li> <li>• Food</li> <li>• High Corrosion</li> </ul>	<ul style="list-style-type: none"> <li>• Céréales</li> <li>• Alimentaire</li> <li>• Cereals</li> <li>• Food</li> </ul>	<ul style="list-style-type: none"> <li>• Température</li> <li>• Abrasion</li> <li>• Collant</li> <li>• Alimentaire</li> <li>• Temperature</li> <li>• Abrasion</li> <li>• Sticky</li> <li>• Food</li> </ul>	<ul style="list-style-type: none"> <li>• Température</li> <li>• Coupant</li> <li>• Collant</li> <li>• Temperature</li> <li>• Sharp</li> <li>• Sticky</li> </ul>	<ul style="list-style-type: none"> <li>• Température</li> <li>• Abrasion</li> <li>• Collant</li> <li>• Atmosphère ATEX</li> <li>• Temperature</li> <li>• Abrasion</li> <li>• Sticky</li> <li>• ATEX atmosphere</li> </ul>

\* Sur demande - On request



## ACIER EMBOUTI

Céréales - Produits légers - Pellets - Produits collants - Produits industriels

PRESSED STEEL - Cereals - Light materials - Pellets - Sticky materials - Industrial materials

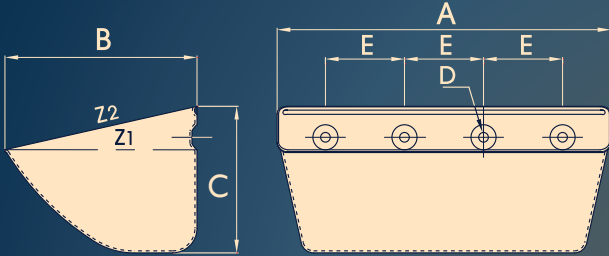

N°	A mm	B mm	C mm	Trous/Holes			Capacité/Capacity		Godets/Buckets /mtr	Poids/Weight Kg						
				Nbr	D mm	E mm	Z2 (l)	Z1 (l)		1,0 mm	1,2 mm	1,5 mm	2,0 mm	2,5 mm	3,0 mm	4,0 mm
JET 08-080	85	80	58	2	8	43	0,21	0,18	15,00	0,11						
JET 10-090	105	92	70	2	8	50	0,38	0,26	14,00	0,15						
JET 12-100	125	103	80	2	8,5	67	0,62	0,45	11,50		0,27					
JET 13-120	138	125	90	2	8,5	70	0,77	0,65	10,50			0,40				
JET 14-120	146	120	90	2	8,5	70	0,87	0,71	10,50			0,40				
JET 15-140	154	140	108	2	9	70	1,25	0,95	8,50			0,54				
JET 18-140	188	147	112	2	9	100	1,71	1,38	8,50			0,65				
JET 20-140	207	142	110	2	9	100	1,79	1,37	8,50			0,73				
JET 22-140	227	142	110	2	9	120	2,00	1,58	8,50			0,77				
JET 23-140	237	142	110	2	9	120	2,08	1,60	8,50			0,81				
JET 20-160	205	169	132	2	11	100	2,60	2,03	7,40				1,18			
JET 23-160	235	169	132	2	11	120	3,00	2,40	7,40				1,33			
JET 24-160	245	169	132	2	11	140	3,18	2,46	7,40				1,41			
JET 26-160	265	169	132	3	11	80	3,50	2,80	7,40				1,50			
JET 28-160	285	169	132	3	11	80	3,76	2,95	7,40				1,59			
JET 30-160	305	169	132	3	11	100	4,00	3,00	7,40				1,65			
JET 33-160	335	169	132	3	11	110	4,32	3,17	7,40				1,79			
JET 35-160	356	176	128	3	11	120	4,53	3,47	7,40				1,87			
JET 37-160	375	176	128	4	11	90	4,85	3,55	7,40				1,91			
JET 20-180	209	188	147	2	11	110	3,15	2,28	6,50				1,24			
JET 24-180	249	188	147	2	11	140	3,90	2,83	6,50				1,53			
JET 26-180	269	188	147	3	11	80	4,30	3,15	6,50				1,57			
JET 28-180	289	188	147	3	11	80	4,60	3,42	6,50				1,71			
JET 30-180	309	188	147	3	11	100	5,00	3,70	6,50				1,80			
JET 33-180	339	188	147	3	11	110	5,55	4,10	6,50				1,94			
JET 35-180	359	188	147	3	11	120	5,90	4,37	6,50				2,05			
JET 37-180	379	188	147	4	11	90	6,30	4,65	6,50					2,73		
JET 42-180	425	188	140	4	11	100	7,35	5,50	6,50					3,10		
JET 25-215	255	216	162	3	11	80	5,20	4,00	5,88				1,90			
JET 28-215	285	216	162	3	11	80	5,90	4,65	5,88				2,09			
JET 30-215	312	216	162	3	11	100	6,70	5,20	5,88				2,24			
JET 33-215A	340	220	162	3	11	110	7,20	5,65	5,88					3,00		
JET 33-215B	340	220	162	3	11	120	7,20	5,65	5,88					3,00		
JET 35-215	360	220	164	3	11	120	7,60	5,85	5,88					3,20		
JET 37-215	380	220	164	4	11	90	8,30	6,50	5,88					3,32		
JET 44-215A	454	220	164	4	11	110	10,00	7,70	5,88					3,78		
JET 44-215B	454	220	164	5	11	90	10,00	7,70	5,88					3,78		
JET 47-215	480	220	164	4	11	120	10,53	8,50	5,88					4,04		
JET 50-215A	510	220	164	4	11	135	11,20	9,00	5,88					4,30		
JET 50-215B	510	220	164	5	11	100	11,20	9,00	5,88					4,30		
JET 53-215	540	220	164	6	11	80	11,87	9,50	5,88					4,56	5,50	
JET 56-215	570	220	164	6	11	90	12,54	10,00	5,88					4,82	5,82	
JET 63-215	640	220	164	7	11	90	14,12	11,30	5,88					5,42	6,50	
JET 33-250	340	253	190	4	11	80	8,95	6,70	5,00						4,10	5,50
JET 35-250	360	253	190	4	11	80	9,50	7,30	5,00						4,35	5,80
JET 37-250	380	253	190	4	11	90	10,10	7,60	5,00						4,60	6,15
JET 42-250	430	253	190	5	11	80	11,50	8,70	5,00						5,25	7,00
JET 44-250	450	253	190	5	11	90	12,10	9,15	5,00						5,50	7,35
JET 47-250	480	253	190	5	11	90	13,00	9,75	5,00						5,80	7,75
JET 53-250	540	253	190	6	11	80	14,60	11,00	5,00						6,60	8,80
JET 56-250	570	253	190	6	11	90	15,35	11,60	5,00						6,95	9,30
JET 63-250	640	253	190	7	11	90	17,20	13,00	5,00						7,80	10,40

Utiliser vis tête fraisée à ergots (voir page 17) / Use countersunk lug bolt (see page 17)

## MATIÈRE PLASTIQUE INJECTÉE PEHD/PA6/PU/PA ATEX

Céréales - Produits légers - Pellets - Produits collants - Produits industriels

PLASTIC MATERIAL INJECTED HDPE/PA6/PU

Cereals - Light materials - Pellets - Sticky materials - Industrial materials

Rondelles plates / Flat washers

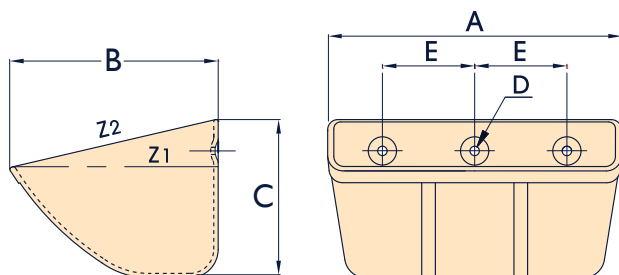

N°	A mm	B mm	C mm	Trous/Holes			Capacité/ Capacity		Godets/ Buckets /mtr	Poids/Weight Kg		
				Nbr	D mm	E mm	Z2 (l)	Z1 (l)		HDPE	PA 6	PU
JET 10-090	110	96	72	2	9	50	0,36	0,29	14	0,073	0,087	0,091
JET 13-120	142	126	84	2	9	70	0,80	0,64	11	0,136	0,163	0,170
JET 15-140	156	157	113	2	8,50	70	1,42	1,13	8,50	0,232	0,277	0,289
JET 18-140	189	150	112	2	8,50	100	1,77	1,38	8,50	0,271	0,324	0,338
JET 20-140	207	157	113	2	8,50	100	1,95	1,62	8,50	0,315	0,376	0,393
JET 22-140	228	152	112	2	8,50	120	1,93	1,49	8,50	0,320	0,382	0,399
JET 23-145	252	158	125	2	8,50	120	2,44	2,20	7	0,403	0,482	0,503
JET 20-170	214	180	129	2	11	110	2,50	1,94	7	0,389	0,465	0,485
JET 23-170	243	175	133	2	11	120	3,20	2,40	7,40	0,446	0,533	0,556
JET 28-170	293	175	133	3	11	80	4,00	2,95	7,40	0,536	0,641	0,669
JET 30-190	320	202	157	3	11	100	5,21	3,96	6	1,039	1,305	1,360
JET 30-215	320	228	168	3	11	100	6,80	5,20	5,88	1,112	1,329	1,387
JET 33-215	350	228	168	3	11	120	7,60	5,80	5,88	1,116	1,334	1,392
JET 35-215	370	228	168	3	11	120	8,00	6,30	5,88	1,289	1,540	1,608
JET 37-215	390	228	168	4	11	90	8,30	6,53	5,88	1,364	1,630	1,701
JET 40-215	420	228	168	4	11	100	9,20	7,10	5,88	1,402	1,675	1,749
JET 44-215	460	228	168	5	11	90	10,30	7,80	5,88	1,504	1,797	1,876
JET 50-215	520	228	168	5	11	100	11,70	9,00	5,88	1,750	2,091	2,183

Utiliser vis tête fraisée à ergots et rondelle plate (voir page 17) / Use countersunk lug bolt and flat washers (see page 17)



## ACIER EMBOUTI

Céréales - Produits légers - Pellets - Produits collants - Produits industriels

PRESSED STEEL

Cereals - Light materials - Pellets - Sticky materials - Industrial materials

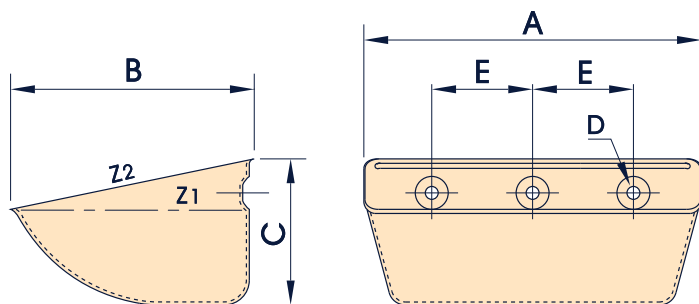

N°	A mm	B mm	C mm	Trous/Holes			Capacité/ Capacity		Godets/ Buckets /mtr	Poids/Weight Kg					
				Nbr	D mm	E mm	Z2 (l)	Z1 (l)		1,0 mm	1,2 mm	1,5 mm	2,0 mm	2,5 mm	3,0 mm
EURO JET 12-100	125	104	78	2	8,50	67	0,55	0,35	12		0,23				
EURO JET 13-120	135	115	81	2	8,50	70	0,65	0,45	12		0,28				
EURO JET 16-130	165	130	87	2	8,50	100	0,95	0,60	12			0,44			
EURO JET 18-140	185	140	92	2	8,50	100	1,29	0,90	10,5			0,55			
EURO JET 20-140	200	136	97	2	11	100	1,41	1,04	10			0,63			
EURO JET 23-165	238	165	110	2	11	120	2,45	1,73	9				1,18		
EURO JET 25-165	258	165	110	3	11	77	2,70	2,00	9				1,27		
EURO JET 28-165	288	165	110	3	11	80	3,00	2,25	9				1,40		
EURO JET 30-180	308	187	120	3	11	100	3,70	2,45	8,13				1,55		
EURO JET 30-215	308	215	140	3	11	100	5,20	3,65	7,14				1,94	2,40	2,90
EURO JET 33-215	338	215	130	3	11	120	5,50	3,95	7,14				1,97	2,50	3,00
EURO JET 37-215	378	215	130	4	11	90	6,20	4,10	7,14				2,25	2,86	3,45
EURO JET 44-215	448	215	130	5	11	90	7,50	5,60	7,14				2,70	3,20	3,85

Utiliser vis tête fraisée à ergots (voir page 17) / Use countersunk lug bolt (see page 17)



## MATIÈRE PLASTIQUE INJECTÉE PEHD/PA6/PU/PA ATEX

Céréales - Produits légers - Pellets - Produits collants - Industrie lourde

PLASTIC MATERIAL INJECTED HDPE/PA6/PU

Cereals - Light materials - Pellets - Sticky materials - Heavy industry

Rondelles plates / Flat washers

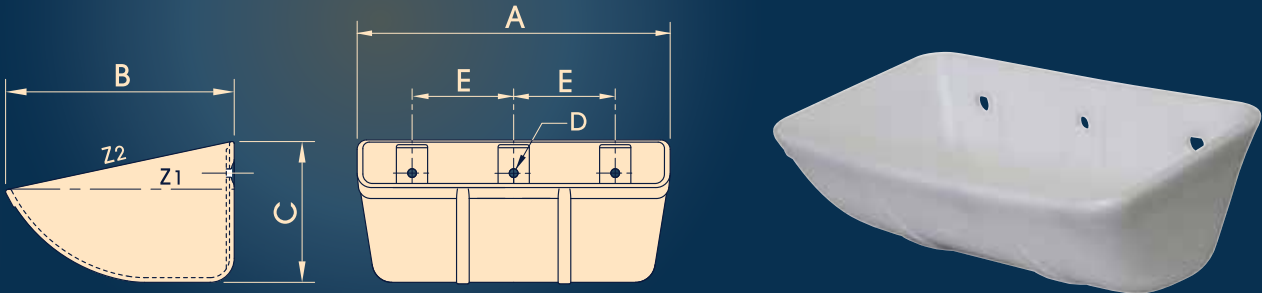

N°	A mm	B mm	C mm	Trous/Holes			Capacité/ Capacity		Godets/ Buckets /mtr	Poids/Weight Kg		
				Nbr	D mm	E mm	Z2 (l)	Z1 (l)		HDPE	PA 6	PU
EURO JET 10-090	110	97	69	2	8	50	0,33	0,24	14	0,077	0,092	0,096
EURO JET 13-120	145	122	83	2	8	70	0,69	0,46	11	0,126	0,151	0,157
EURO JET 15-120	160	131	85	2	8	80	0,94	0,60	11	0,156	0,186	0,195
EURO JET 18-140	188	149	93	2	8	100	1,20	0,84	10,5	0,264	0,315	0,329
EURO JET 20-165	207	176	115	2	11	100	2,17	1,67	9	0,361	0,431	0,450
EURO JET 23-165	242	172	117	2	11	120	2,42	1,60	9	0,380	0,454	0,474
EURO JET 28-165	292	170	116	3	11	80	2,90	2,00	9	0,459	0,548	0,573
EURO JET 30-180	318	186	135	3	11	100	4,04	2,97	8	0,766	0,915	0,955
EURO JET 33-215	339	222	145	3	11	120	5,24	3,79	7,14	0,746	0,891	0,931
EURO JET 37-215	383	219	142	4	11	90	6,06	4,20	7,14	0,822	0,982	1,025
EURO JET 44-215	455	223	143	5	11	90	7,39	4,59	7,14	1,148	1,372	1,432

Utiliser vis tête fraisée à ergots et rondelle plate (voir page 17) / Use countersunk lug bolt and flat washers (see page 17)



## MATIÈRE PLASTIQUE INJECTÉE PEHD/PA6

Céréales - Produits légers - Pellets - Produits industriels

PLASTIC MATERIAL INJECTED HDPE/PA6

Cereals - Light materials - Pellets - Industrial materials

Rondelles plates / Flat washers

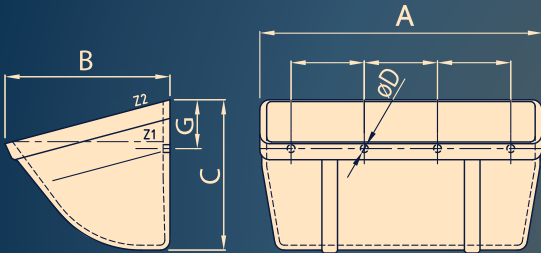

N°	A mm	B mm	C mm	Trous/Holes			Capacité/ Capacity		Godets/ Buckets /mtr	Poids/Weight Kg			
				Nbr	D mm	E mm	G mm	Z2 (c)		Z1 (c)	HDPE	PA 6	PU
JET CC 4x3	10/090	114	90	Sur demande / On request				0,40	0,30	11,25	0,10	0,12	0,12
JET CC 5x4	13/100	138	115					0,75	0,61	8,75	0,17	0,20	0,21
JET CC 6x4	16/100	164	115					0,95	0,74	8,75	0,23	0,27	0,29
JET CC 7x4	18/100	186	115					1,13	0,87	8,75	0,26	0,31	0,32
JET CC 7x5	18/140	192	140					1,74	1,35	7,15	0,38	0,45	0,47
JET CC 8x5	20/140	216	140					2,00	1,56	7,15	0,37	0,44	0,46
JET CC 9x5	23/140	242	140					2,22	1,71	7,15	0,46	0,55	0,57
JET CC 10x5	26/140	268	140					2,53	1,97	7,15	0,49	0,58	0,61
JET CC 8x6	20/170	215	170					2,90	2,10	6,00	0,54	0,64	0,67
JET CC 9x6	23/170	242	170					3,30	2,52	6,00	0,60	0,71	0,74
JET CC 10x6	26/170	266	170					3,70	2,75	6,00	0,64	0,76	0,79
JET CC 11x6	28/170	292	170					4,10	3,10	6,00	0,69	0,82	0,86
JET CC 11x7	30/200	302	200					5,70	4,43	5,25	0,99	1,18	1,23
JET CC 11x7 D	30/200	285	200					5,75	4,38	4,60	1,36	1,62	1,69
JET CC 12x7	32/200	326	200					6,18	4,79	5,25	1,20	1,43	1,49
JET CC 12x7 D	32/200	340	200					7,00	5,33	4,60	1,57	1,78	1,95
JET CC 14x7	37/200	378	200					7,30	5,62	5,25	1,19	1,41	1,48
JET CC 20x7	52/200	532	200					10,80	8,30	5,25	2,20	2,63	2,75
JET CC 11x8	30/230	302	230					6,90	5,88	4,60	1,41	1,67	1,75
JET CC 12x8	32/230	320	230					8,30	6,29	4,60	1,51	1,79	1,87
JET CC 14x8	37/230	380	230					9,70	7,57	4,60	1,70	2,02	2,11
JET CC 16x8	42/230	430	230					11,10	8,66	4,60	1,90	2,26	2,36
JET CC 18x8	47/230	482	230	12,50	9,61	4,60	2,10	2,49	2,60				
JET CC 20x8	52/230	532	230	13,90	10,86	4,60	2,37	2,83	2,96				
JET CC 22x8	57/230	582	230	15,30	12,12	4,60	2,47	2,93	3,06				

Utilisé vis à tête plate à ergot (voir page 17) / Used flat lug bolt (see page 17)

Autre perçage sur demande / Other punching hole on request

## MATIÈRE PLASTIQUE INJECTÉE PEHD/PA6

Céréales - Produits légers - Pellets - Produits industriels

PLASTIC MATERIAL INJECTED HDPE/PA6

Cereals - Light materials - Pellets - Industrial materials

Rondelles plates / Flat washers

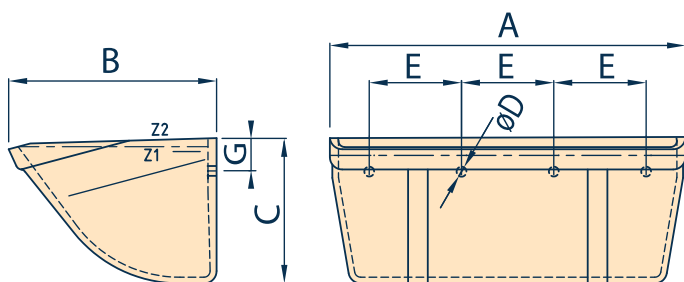

N°	A mm	B mm	C mm	Trous/Holes			Capacité/ Capacity		Godets/ Buckets /mtr	Poids/Weight Kg			
				Nbr	D mm	E mm	G mm	Z2 (ø)		Z1 (ø)	HDPE	PA 6	PU
JET CC 4x3	10/090	114	90	80				0,40	0,30	11,25	0,10	0,12	0,12
JET CC 5x4	13/100	138	115	75				0,65	0,61	11,25	0,15	0,18	0,19
JET CC 6x4	16/100	164	115	75				0,78	0,74	11,25	0,21	0,25	0,26
JET CC 7x4	18/100	186	115	75				0,92	0,87	11,25	0,24	0,29	0,30
JET CC 7x5	18/140	192	140	100				1,52	1,35	8,50	0,33	0,39	0,41
JET CC 8x5	20/140	216	140	100				1,74	1,56	8,50	0,32	0,38	0,40
JET CC 9x5	23/140	242	140	100				1,94	1,71	8,50	0,40	0,48	0,50
JET CC 10x5	26/140	268	140	100				2,21	1,97	8,50	0,43	0,51	0,53
JET CC 8x6	20/170	215	170	120				2,38	2,10	7,50	0,47	0,56	0,58
JET CC 9x6	23/170	242	170	120				2,70	2,52	7,50	0,53	0,63	0,66
JET CC 10x6	26/170	266	170	120				3,05	2,75	7,50	0,56	0,67	0,69
JET CC 11x6	28/170	292	170	120				3,35	3,10	7,50	0,60	0,71	0,74
JET CC 11x7	30/200	302	200	145				4,85	4,43	6,50	0,90	1,07	1,12
JET CC 11x7 D	30/200	285	200	170				5,75	4,38	4,60	1,27	1,51	1,57
JET CC 12x7	32/200	326	200	145				5,25	4,79	6,50	1,05	1,25	1,30
JET CC 12x7 D	32/200	340	200	170				7,00	5,33	4,60	1,48	1,76	1,84
JET CC 14x7	37/200	378	200	145				6,20	5,62	6,50	1,08	1,28	1,34
JET CC 20x7	52/200	532	200	148				10,80	8,30	5,25	2,03	2,22	2,32
JET CC 11x8	30/230	302	230	170				5,90	5,88	5,50	1,30	1,54	1,61
JET CC 12x8	32/230	328	230	170				7,10	6,29	5,50	1,38	1,64	1,71
JET CC 14x8	37/230	380	230	170				8,30	7,57	5,50	1,56	1,85	1,93
JET CC 16x8	42/230	430	230	170				9,50	8,66	5,50	1,74	2,07	2,16
JET CC 18x8	47/230	482	230	170				10,70	9,61	5,50	1,92	2,28	2,38
JET CC 20x8	52/230	532	230	170				11,90	10,86	5,50	2,08	2,47	2,58
JET CC 22x8	57/230	582	230	170				13,10	12,12	5,50	2,26	2,68	2,80

Sur demande /  
On request

Utilisé vis à tête plate à ergot (voir page 17) / Used flat lug bolt (see page 17)

Autre perçage sur demande / Other punching hole on request

## MATIÈRE PLASTIQUE INJECTÉE PEHD/PA6

Céréales - Produits légers - Pellets - Produits industriels

PLASTIC MATERIAL INJECTED HDPE/PA6

Cereals - Light materials - Pellets - Industrial materials

Rondelles plates / Flat washers

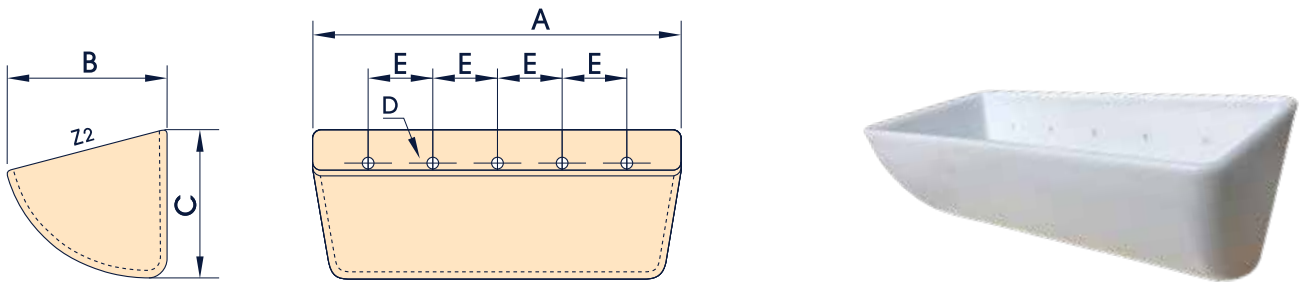

N°	A mm	B mm	C mm	Trous/Holes			Capacité/ Capacity		Godets/ Buckets /mtr	Poids/Weight Kg		
				Nbr	D mm	E mm	G mm	Z2 (c)		Z1 (c)	HDPE	PA6
MaxijET 20x8 52/230	519	225	211	Sur demande / On request			13,50	10,55	4,4	2,70	3,23	3,38

Utilisé vis à tête plate à ergot (voir page 17) / Used flat lug bolt (see page 17)



## ACIER EMBOUTI

Céréales - Produits légers - Pellets  
 PRESSED STEEL  
 Cereals - Light materials - Pellets

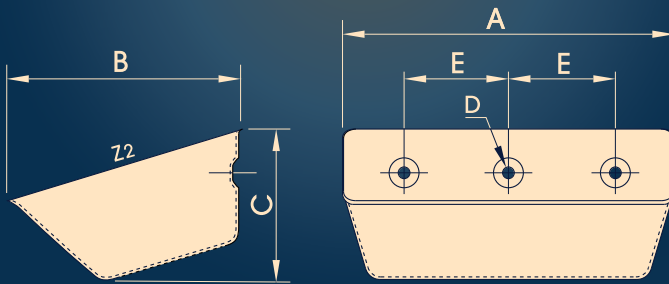

N°	A mm	B mm	C mm	Trous/Holes			Capacité/ Capacity Z2 (l)	Godets/ Buckets /mtr	Poids/Weight Kg			
				Nbr	D mm	E mm			1,0 mm	1,5 mm	2,0 mm	10,0 mm
JET-LIFT 13-120	134	115	67	2	8,50	70	0,45	18,50		0,23		
JET-LIFT 18-140	185	139	90	2	8,50	100	1,15	14		0,45		
JET-LIFT 23-165	238	164	102	2	8,50	120	1,95	12,50			0,84	
JET-LIFT 28-165	290	167	108	3	8,50	90	2,89	11,40			1,08	

Utiliser vis tête fraisée à ergots (voir page 17) / Use countersunk lug bolt (see page 17)



# Columbus DIN 15232

## ACIER EMBOUTI

Céréales - Produits légers - Pellets

PRESSED STEEL

Cereals - Light materials - Pellets

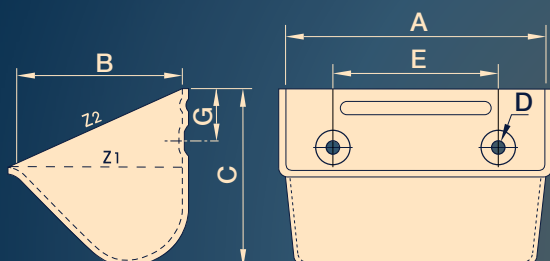

N°	A mm	B mm	C mm	Trous/Holes			Capacité/ Capacity		Godets/ Buckets /mtr	Poids/Weight Kg			
				Nbr	D mm	E mm	Z2 (l)	Z1 (l)		1,0 mm	1,5 mm	2,0 mm	3,0 mm
COL 08-080	80	80	80	2	7	40	0,25	0,14	10,00	0,14			
COL 10-090	100	90	92	2	8	50	0,41	0,26	8,00	0,16			
COL 12-100	120	100	105	2	8	70	0,63	0,45	7,00	0,23			
COL 14-115	140	112	117	2	8	90	0,96	0,60	6,50	0,30			
COL 16-125	160	124	128	2	9	100	1,20	0,75	6,00		0,55		
COL 18-130	180	130	135	2	9	115	1,55	1,00	5,50		0,65		
COL 20-140	200	138	145	2	9	130	2,15	1,30	5,00		0,80		
COL 22-145	225	144	153	3	9	70	2,50	1,50	4,50		0,92		
COL 25-150	250	150	160	3	9	77	3,10	1,85	4,50		1,05		
COL 27-155	275	155	165	3	11	95	3,70	2,30	4,00		1,20		
COL 30-160	300	160	170	3	11	105	4,50	2,70	4,00		1,34		
COL 32-170	325	172	180	3	11	115	5,50	3,20	3,50		1,55		
COL 35-185	350	185	190	4	11	90	6,50	3,80	3,50		1,77		
COL 40-200	400	200	207	4	11	100	8,70	5,30	3,00			2,90	

Utiliser vis tête fraisée à ergots (voir page 17) / Use countersunk lug bolt (see page 17)

# Columbus DIN 15232

## MATIÈRE PLASTIQUE INJECTÉE PEHD/PA6

Céréales - Produits légers - Pellets

PLASTIC MATERIAL INJECTED HDPE/PA6

Cereals - Light materials - Pellets

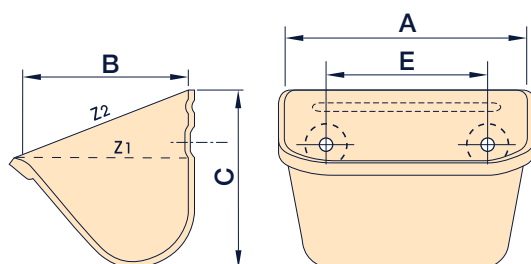

N°	A mm	B mm	C mm	Trous/Holes			Capacité/ Capacity		Godets/ Buckets /mtr	Poids/Weight Kg	
				Nbr	D mm	E mm	Z2 (l)	Z1 (l)		HDPE	PA 6
COL 08-080	80	80	80	2	8	40	0,23	0,13	10,00	0,05	0,06
COL 10-090	100	92	92	2	8	50	0,38	0,24	8,00	0,07	0,09
COL 12-100	120	102	105	2	8	70	0,58	0,39	7,00	0,10	0,13
COL 14-115	140	114	117	2	9	90	0,85	0,52	6,50	0,15	0,18
COL 16-125	160	126	128	2	9	100	1,20	0,76	6,00	0,20	0,25
COL 18-130	180	132	135	2	10	115	1,60	0,95	5,50	0,28	0,35
COL 20-140	200	140	145	2	10	130	2,00	1,20	5,00	0,34	0,42
COL 22-145	225	145	153	3	11	70	2,30	1,35	4,50	0,36	0,44
COL 25-150	250	152	160	3	11	77	2,80	1,65	4,50	0,43	0,54
COL 27-155	275	156	165	3	11	95	3,25	2,20	4,00	0,54	0,66
COL 30-160	300	163	170	3	11	105	4,00	2,60	4,00	0,70	0,83
COL 32-170	325	175	180	3	12,5	115	5,00	3,20	3,50	0,90	1,15
COL 35-185	350	190	190	4	12,5	90	6,00	3,50	3,50	1,10	1,40
COL 40-200	400	206	207	4	12,5	100	8,00	5,00	3,00	1,50	1,90

Utiliser vis tête fraisée à ergots (voir page 17) / Use countersunk lug bolt (see page 17)

Document non contractuel - Non contractual document



## ACIER SOUDÉ / WELDED STEEL Industrie lourde / Heavy industry

Épaisseur, perçage et options de renforts à définir par le client  
Thickness, drilling and reinforcements options to be defined by the customer

### DIN 15232

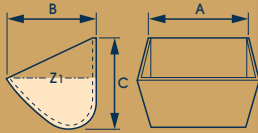

N°	A mm	B mm	C mm	Z1 (l)	Godets / Buckets /mtr
15232-NJS2 160-125	160	125	132	0,90	7,00
15232-NJS2 200-140	200	140	150	1,40	6,00
15232-NJS2 250-160	250	160	170	2,24	5,50
15232-NJS2 315-180	315	180	190	3,55	5,00
15232-NJS2 400-200	400	200	212	5,50	4,50
15232-NJS2 500-224	500	224	236	9,00	4,00
15232-NJS2 630-250	630	250	265	14,00	3,50
15232-NJS2 800-280	800	280	300	23,30	3,00

### DIN 15234

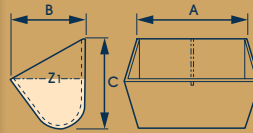

N°	A mm	B mm	C mm	Z1 (l)	Godets / Buckets /mtr
15234-NJS4 160-160	160	160	200	1,90	4,50
15234-NJS4 200-160	200	160	200	2,40	4,50
15234-NJS4 250-200	250	200	250	4,60	3,50
15234-NJS4 315-200	315	200	250	5,80	3,50
15234-NJS4 400-224	400	224	280	9,40	3,00
15234-NJS4 500-250	500	250	315	14,90	3,00
15234-NJS4 630-280	630	280	355	23,50	2,50
15234-NJS4 800-315	800	315	400	37,30	2,00
15234-NJS4 1000-355	1000	355	450	58,30	2,00

### DIN 15233

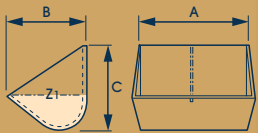

N°	A mm	B mm	C mm	Z1 (l)	Godets / Buckets /mtr
15233-NJS3 160-160	160	160	180	1,20	5,00
15233-NJS3 200-160	200	160	180	1,50	5,00
15233-NJS3 250-200	250	200	224	3,00	4,00
15233-NJS3 315-200	315	200	224	3,80	4,00
15233-NJS3 400-224	400	224	250	5,90	3,50
15233-NJS3 500-250	500	250	280	9,30	3,00
15233-NJS3 630-280	630	280	315	14,60	3,00
15233-NJS3 800-315	800	315	355	23,30	2,50
15233-NJS3 1000-355	1000	355	400	37,60	2,00

### DIN 15235

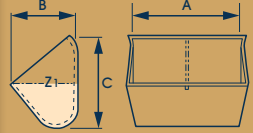

N°	A mm	B mm	C mm	Z1 (l)	Godets / Buckets /mtr
15235-NJS5 160-160	160	160	224	1,90	4,00
15235-NJS5 200-160	200	160	224	2,40	4,00
15235-NJS5 250-200	250	200	280	4,60	3,00
15235-NJS5 315-200	315	200	280	5,80	3,00
15235-NJS5 400-224	400	224	315	9,40	3,00
15235-NJS5 500-250	500	250	355	14,90	2,50
15235-NJS5 630-280	630	280	400	23,50	2,00
15235-NJS5 800-315	800	315	450	37,30	2,00
15235-NJS5 1000-355	1000	355	500	58,30	1,50

## OPTIONS POSSIBLES TOUS GOGETS MÉTAL POSSIBLE OPTIONS ALL STEEL BUCKETS

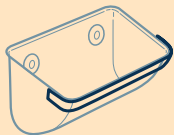

**Plat de renfort avant soudé**  
Welded front reinforcement

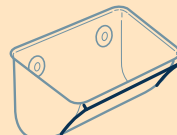

**Moulure de renfort avant**  
Front reinforcement moulding



**Plat de renfort arrière boulonné**  
Bolted rear reinforcement



**Moulure de renfort arrière**  
Rear reinforcement moulding

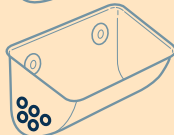

**Perçages latéraux**  
Lateral borings



**Perçages au fond**  
Bottom borings

## GOGETS SPÉCIAUX SPECIAL BUCKETS

Études technique et devis sur demande - Technical research and quotation on request



## BOULONNERIE BOLTS

Pour godet à trous emboutis / For bucket with recessed holes

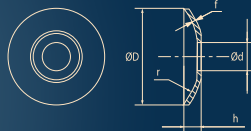
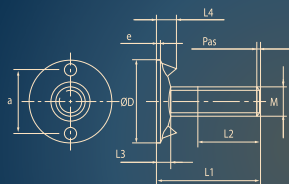

Vis à tête fraisée à ergots /  
Countersunk lug bolt



Codification	M	L1	ØD	L2	Pas	L3	L4	a	eMax
<b>Zinc*</b>									
04VEZS08030	8	30	25	20	1,25	4,5	6	18	1
04VEZX08035	8	35	28	18	1,25	4,5	6	20	1
04VEZS10040	10	40	35	30	1,50	5,5	7	25	1,5
04VEZX10036	10	36	35	20	1,50	7,0	7	22	2,0

Codification	M	ØD	ød	h	r	f
<b>Zinc*</b>						
50ZREZ0829	8	29	8,5	5,2	22,8	1,2
50ZREZ1038	10	38	11	5,3	45,5	2,0

Codification	Ecrous/Nuts Zinc*	Codification	Ecrous freins/ Self locking nuts Zinc*
04EHZ08	M8	04EFZ08	M8
04EHZ10	M10	04EFZ10	M10

\* Disponible en inox / Available in stainless steel

Pour godet à trous non emboutis / For bucket with no recessed holes

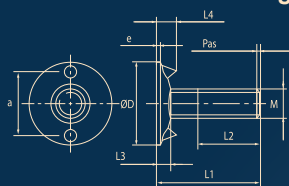

Vis à tête fraisée à ergots /  
Countersunk lug bolt



Codification	M	L1	ØD	L2	Pas	L3	L4	a	eMax
<b>Zinc*</b>									
04VEZS08030	8	30	25	20	1,25	4,5	6	18	1
04VEZX08035	8	35	28	18	1,25	4,5	6	20	1
04VEZS10040	10	40	35	30	1,50	5,5	7	25	1,5
04VEZX10036	10	36	35	20	1,50	7,0	7	22	2,0

Pour godet plastique / For plastic bucket				
Codification	M	ØD	ød	f
<b>Zinc*</b>				
04RPZ0830	8	30	8,3	1,5
04RPZ1036	10	36	10,5	2,0

Pour godet métal / For steel bucket				
Codification	M	ØD	ød	f
<b>Zinc*</b>				
04RPZ0818	8	18	8,3	1,5
04RPZ1022	10	22	10,5	2,0

Codification	Ecrous/Nuts Zinc*	Codification	Ecrous freins/ Self locking nuts Zinc*
04EHZ08	M8	04EFZ08	M8
04EHZ10	M10	04EFZ10	M10

\* Disponible en inox / Available in stainless steel

## JONCTIONS DE SANGLE BELT FASTENERS

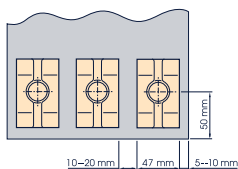

Forgées - Drop forged steel

MAXIGRIP 1 - ≤ 630 N/mm

MAXIGRIP 2 - 800 N/mm à 1 600 N/mm

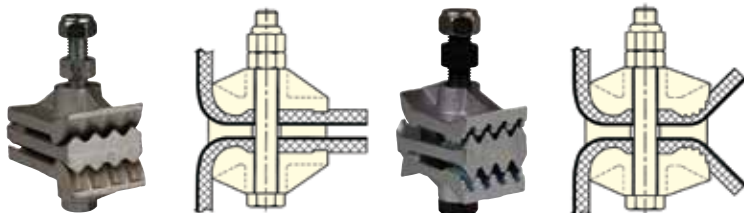

### MÉCANO SOUDÉES WELDED STEEL

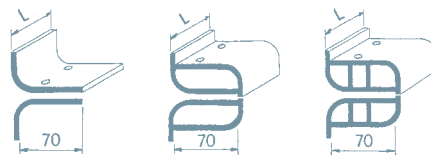

S	D	DR
100 N/mm à 315 N/mm	400 N/mm à 630 N/mm	800 N/mm à 1 000 N/mm
L 50 - 98 - 128 - 148		

## COMMENT MESURER UN GODET ? HOW TO MEASURE A BUCKET ?

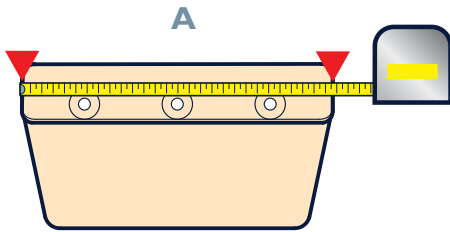

**A**

**Largeur du godet:**  
*Mesure extérieure*

**Width of the bucket:**  
*External measurement*

A

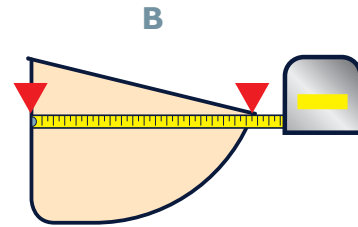

**B**

**Profil du godet:**  
*Godet posé le dos contre un mur*  
*Mesure horizontale du dos au bec*

**Profile of the bucket:**  
*Bucket lying on its back against a wall*  
*Measurement horizontal from the back to the edge*

B

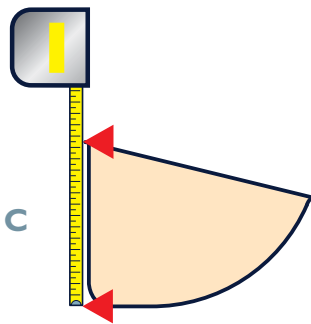

**C**

**Hauteur du godet:**  
*Mesure de la hauteur hors tout*

**Height of the bucket:**  
*Measurement of the total height*

C

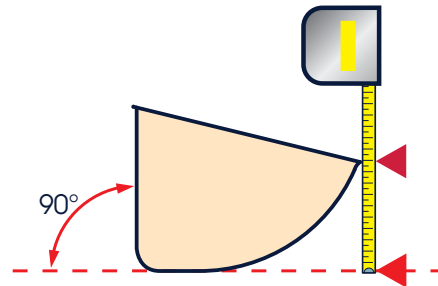

**Hauteur au bec:**  
*Godet posé le dos contre un mur*  
*Mesure de la hauteur au bec*

**Height at the edge:**  
*Bucket lying on its back against a wall*  
*Measurement from the height to the edge*

**Epaisseur:**  
*Mesure au pied à coulisse de l'épaisseur*

**Thickness:**  
*Measurement of the thickness with a caliper rule*

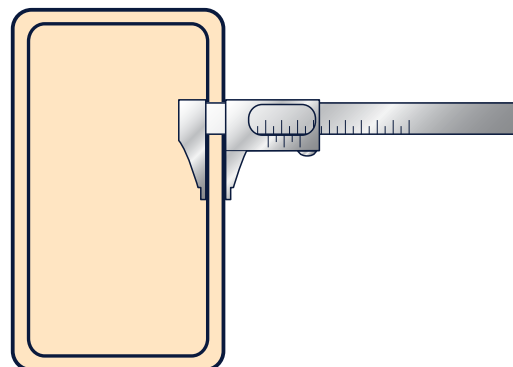

# Guide de sélection / Selection guide:

## Boîtier de connexion / Connection box

### M-JET LINK

Boîtier de connexion  
Connection box



- 5
- 4
- 1
- 3
- 2

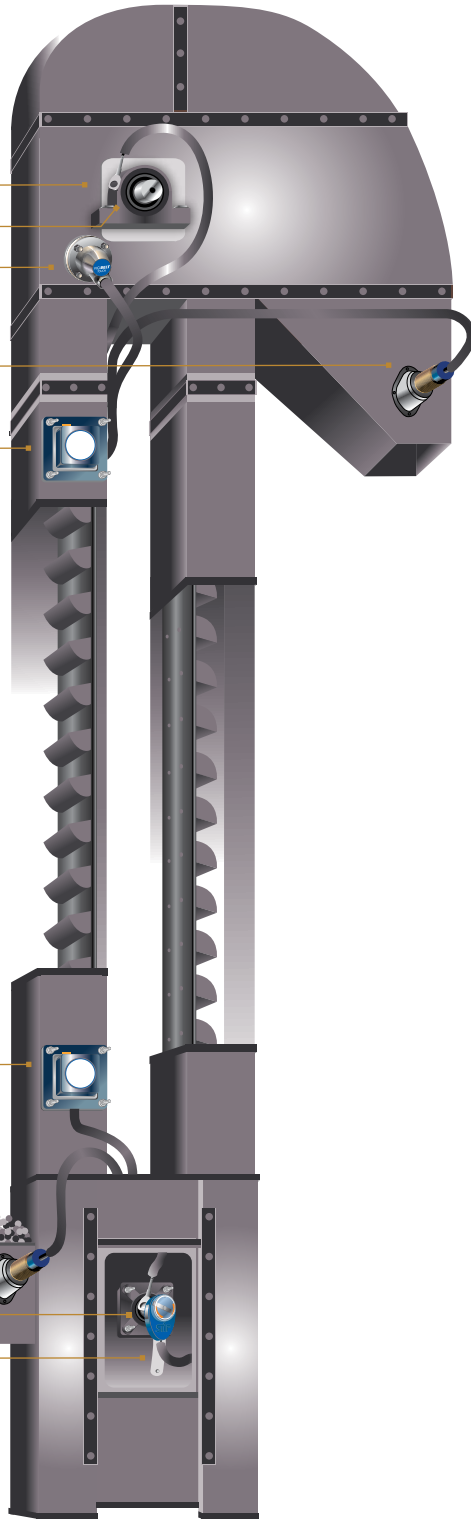

Module de contrôle  
Hazard monitoring

M-JET

M-JET+



M-JET

Module de contrôle sans écran d'affichage  
Hazard monitoring without display

ou  
or

M-JET+

Module de contrôle avec écran d'affichage  
Hazard monitoring with display

- 2
- 3
- 5
- 4

## Appareils de sécurité / Safety equipments

### DÉPORT DE SANGLE / MISALIGNMENT

1 **Vigibelt Touch**  
Déport de sangle détecté par contact / Belt alignment detector by contact  
ou  
or



2 **Vigibelt CDM 80 C**  
Déport de sangle détecté sans contact / Belt alignment detector without contact



### BOURRAGE / LEVEL & CHOKE

3 **Vigimat DNC 30**  
Sonde anti-bourrage  
Level & choke sensor



### SOUS-VITESSE / UNDER SPEED

4 **Vigiro IP26**  
Contrôleur de rotation  
Rotation under speed switch



### TEMPÉRATURE / TEMPERATURE

5 **Vigitherm GST 100**  
Sonde de température pour pallier  
Bearing temperature sensor



Document non contractuel - Non contractual document





[www.stifnet.com](http://www.stifnet.com)

## EUROPE



### STIF (Siège social) Usine

Z.A. de la Lande  
49170 Saint-Georges-sur-Loire  
FRANCE  
Tél.: +33 2 41 72 16 82  
Fax: +33 2 41 39 32 12  
E mail: [sales@stifnet.com](mailto:sales@stifnet.com)  
Web: [www.stifnet.com](http://www.stifnet.com)

### STIF IBERICA Bureau commercial

Carrer Doctor Zamenhof, 22. Local  
08800 Vilanova i La Geltrú  
BARCELONA - ESPAÑA  
Tel.: +34 938 950 262  
Fax: +34 938 950 298  
E mail: [ventas@stifiberica.es](mailto:ventas@stifiberica.es)  
Web: [www.stifnet.com](http://www.stifnet.com)

### STIF Eastern Europe Bureau commercial

Saltovskoe Hwy., 43,  
Letter G-3, office 303  
61038 KHARKOV  
UKRAINE  
Ph.: +38 057 728 0840  
E mail: [stifee@stifnet.com](mailto:stifee@stifnet.com)  
Web: [www.stifnet.com](http://www.stifnet.com)

### STIF development Ltd Bureau commercial

10 Trinity House  
Trinity Gardens  
Frodsham  
WA67GB –  
UNITED KINGDOM  
E mail: [info@macclancyandsons.co.uk](mailto:info@macclancyandsons.co.uk)  
Web: [www.vigilexuk.com](http://www.vigilexuk.com)

## ASIE



### STIF (SUZHOU) Usine

Unit 7, N° 2318  
East Taihu Lake Road  
Wuzhong District, Suzhou City  
Jiangsu Province, CHINA  
Ph.: +86 512 6656 8968  
Fax: +86 512 6656 9128  
E mail: [sales@stif.cn](mailto:sales@stif.cn)  
Web: [www.stif.cn](http://www.stif.cn)

### STIF ASIA Bureau commercial

2 Jurong East St 21  
#04-28K IMM Building  
SINGAPORE 609601  
Ph.: +65 6563-2098  
Fax: +65 6562-6083  
E mail: [sales@stif.com.sg](mailto:sales@stif.com.sg)  
Web: [www.stifnet.com](http://www.stifnet.com)

### PT. STIF INDONESIA Bureau commercial

Jl. Ratna no. 1A  
BEKASI – 17412  
INDONESIA  
Ph.: +62 21 8499 6745  
Fax: +62 21 8499 5151  
E mail: [indo@stif.com.sg](mailto:indo@stif.com.sg)  
Web: [www.stifnet.com](http://www.stifnet.com)

## AMÉRIQUE

### STIF AMERICA Bureau commercial

Oficina 4-04  
Centro Empresarial – Mar del Sur  
Calle Primera El Carmen – Panamá  
Rep. de Panamá  
Tel.: +507 393-3787  
Fax: +507 393-7467  
E mail: [stifamerica@stifnet.com](mailto:stifamerica@stifnet.com)  
Web: [www.stifnet.com](http://www.stifnet.com)



les composants de votre réussite

